



SERFILCO®

a e of

Chemical resistant pumps & filters engineered for industry

SERIES 'HK' | HORIZONTAL PUMPS

High Efficiency and Low Energy Usage for:

Acids | Alkalis | Amines | Chemicals | Corrosive | High Temperature | High Pressure | High Viscosity

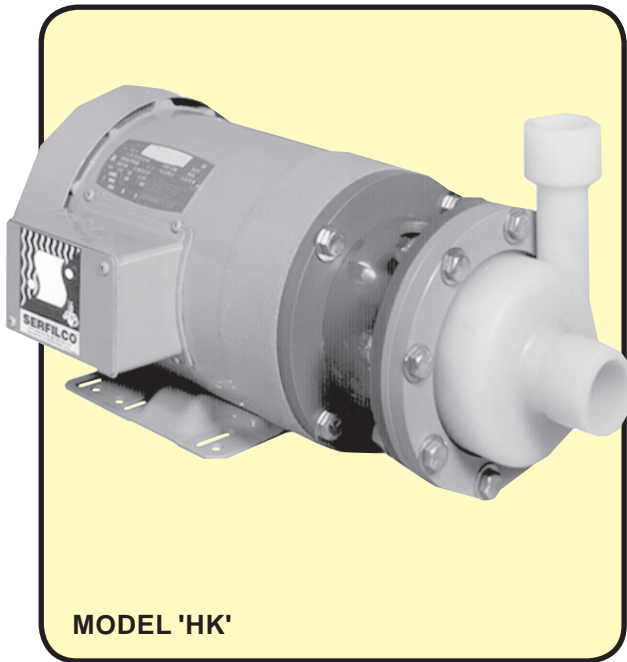

MODEL 'HK'

- Flows to 78 U.S. GPM or 53 FT. TDH @ 60 Hz (246 LPM or 11m @ 50 Hz)
- Non-metallic solution contact - CPVC or 100% PVDF (See a chemical resistance chart)
- Single or double mechanical seal Carbon/ceramic or silicon carbide EPDM or Viton® elastomers
- Centrifugal — quiet, vibration-free
- Standard models provide non-overloading full flow with liquids to 1.2 S.G.
- Chemical duty motor (1 - 1 1/2 HP) Sealed oversized bearings, cast iron end bells Corrosion resistant two-part epoxy enamel finish, stainless steel name plate 1.15 service factor at 50 and 60 Hz

Series 'HK' Horizontal Pumps feature "total" Available close-coupled to minimize size or long-chemical resistance with non-metallic construction or coupled with bearing pedestal base plate and motor. all wetted components. The molded, semi-enclosed All close-coupled pumps are driven by chemical impellers are designed to provide maximum pumping duty motors suitable for continuous duty in corrosive efficiency. These pumps feature external single seal environments. or double water-flushed mechanical seal with choice of EPDM or Viton elastomer materials.

Pumps are ideal for transferring and recirculating industrial solutions, plating solutions, process chemicals and other fluid handling applications.

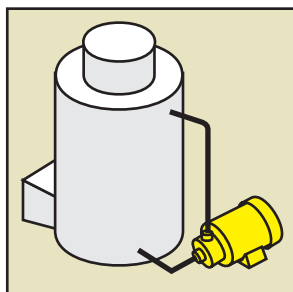

FUME SCRUBBING

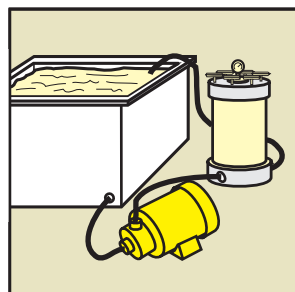

CLEANING & DESCALING

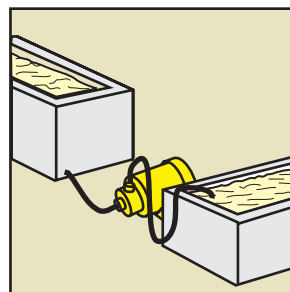

WASTE TREATMENT

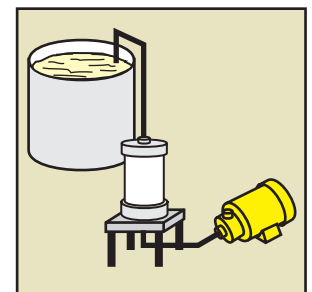

SOLUTION TRANSFER
w/PRIMING CHAMBER



SERIES 'HK' | HORIZONTAL PUMPS

2-00 MacArthur Blvd. Northbrook, IL. USA 60062 www.serfilco.co(800) 323 - 5431

Series 'HK' Pumps have 1" MNPT suction x 1" MNPT discharge and are available in CPVC with PVDF suction casing or 100% PVDF. Elastomers are Viton, or EPDM.

All models utilize a molded, semi-enclosed impeller. Mechanical seal is Type 21, externally mounted and not in solution contact. Double water flushed mechanical seal is recommended for applications where abrasives or salts are present, or for conditions where metal deposition will occur. In addition, double water flush sealed pumps will permit dry run operation.

Mechanical seals are available with carbon/ceramic or all silicon carbide seal faces.

Motors are chemical duty with sealed oversize bearings, cast iron end bells, two-part epoxy finish, and stainless steel tag. Motors are rated with 1.15 service factor at 50 or 60 Hz.

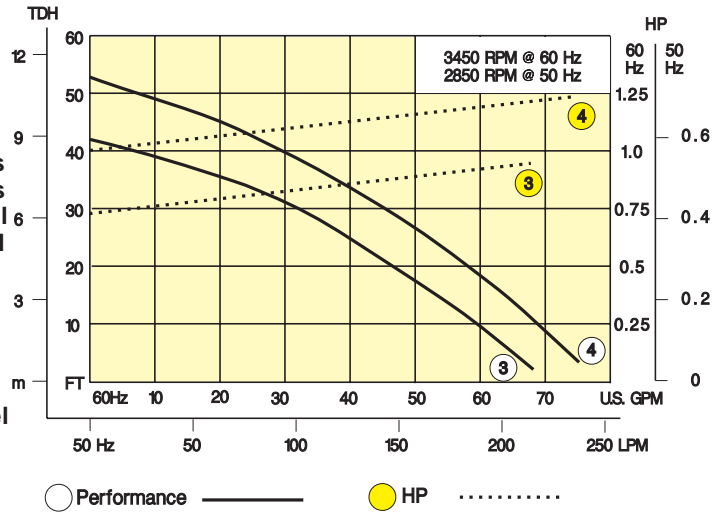

DIMENSIONS

MODEL HK1-1/2x1-1/2

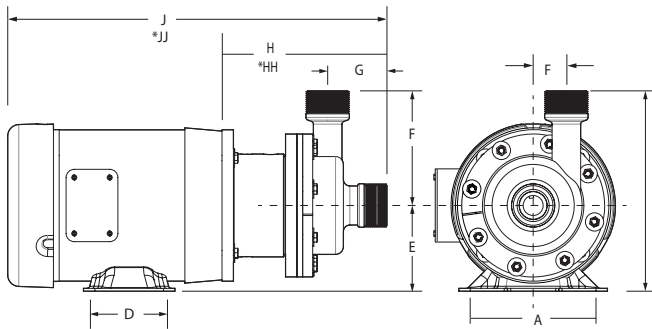

DIMENSIONS						
	A	B	C	D	E	F
Inches (mm)	5-1/2 (140)	- (22-)	1-1/2 (38)	4 (102)	3-1/2 (8-)	5 (127)

G	H	* HH	J	* JJ
2--/16 (65)	7-1/4 (184)	7-1/4 (184)	18-1/4 (464)	18-1/4 (464)

HH and JJ are double seal dimensions.

ORDERING INFORMATION

TABLE I

Select flow curve with desired performance. Select CPVC or PVDF. All models have carbon/SF¹ ceramic seal, Viton elastomers, and three phase motor. Motor HP is non-overloading for full flow at 1.2 S.G

CURVE	CPVC SINGLE SEAL		CPVC DOUBLE SEAL		
	MODEL	PRICE CODE NO.	MODEL	PRICE CODE NO.	
3	HK1 x1 CK3V(M2) D1.0	47-0832 F	HK1 x1 CK3V(M2 X M1) D1.0	47-0835 F	
4	HK1 x1 CK4V(M2) D1.5	47-0842 H	HK1 x1 CK4V(M2 x M1) D1.5	47-0845 H	
		PVDF SINGLE SEAL		PVDF DOUBLE SEAL	
3	HK1 x1 K3V(M2) D1.0	47-0-32 F	HK1 x1 K3V(M2 x M1) D1.0	47-0-35 F	
4	HK1 x1 K4V(M2) D1.5	47-0-42 H	HK1 x1 K4V(M2 x M1) D1.5	47-0-45 H	

SF= Silica-free ceramic.



SERIES 'HK' | HORIZONTAL PUMPS

a e

2-00 MacArthur Blvd. Northbrook, IL. USA 60062 www.serfilco.co(800) 323 - 5431

ORDERING INFORMATION Con't

TABLE II

To construct model/price code number for pump with EPDM elastomers, SiC seal, three phase motor or increased horsepower, see chart below. Use price code number to order.

EXAMPLE:

PUMP + IMPELLER + ELASTOMER & MECHANICAL SEAL + MOTOR = PRICE CODE NO.
 HK1½ x 1½K + 3 + V(M8 x M1) + D1.5 = 47-0938 H

PUMP		
MATERIAL	MODEL	PRICE CODE NO.
CPVC / PVDF	HK1-1/2 x 1-1/2CK	47-08
100% PVDF	HK1-1/2 x 1-1/2K	47-09

IMPELLER	
FLOW CURVE	ADD TO MODEL & PCN
3	3
4	4

"O"-RING MECHANICAL SEAL		
MATERIAL (SOLUTION CONTACT)	ADD TO . . .	
	MODEL	PCN
SINGLE SEAL		
EPDM, carbon SF ceramic	L(M1)	1
EPDM, silicon, carbide	L(M8)	0
Viton, carbon SF ceramic	V(M2)	2
Viton, silicon carbide	V(M8)	7
DOUBLE SEAL		
EPDM, carbon SF ceramic	L(M1xM1)	4
EPDM, silicon, carbide	L(M8xM1)	9
Viton, carbon SF ceramic	V(M2xM1)	5
Viton, silicon carbide	V(M8xM1)	8

MOTOR - TEFC					PUMP & MOTOR SHIP. WT. (Lbs.)
HP	I-PHASE ²		3-PHASE ³		
	MODEL	PCN	MODEL	PCN	
1	-C1.0	E	-D.1	F	35
1-1/2	-C1.5	G	-D1.5	H	40

SF Silica-free ceramic. ² Single Phase 115-190-230V/1/50-60 ³ Three Phase 230-460V/3/50-60 or 380-415V/3/50

OPTIONAL

LONG-COUPLED KIT

Long-Coupled Kit includes cast iron bearing pedestal frame, fiberglass reinforced channel, flexible coupling and guard. To order unit assembled with motor, add 42-0204.

TO ORDER LONG COUPLED KIT	ADD TO MODEL NO.	PRICE CODE NO.
For 143T & 145T frame (HK1-1/2 x 1-1/2 pump)	- LCK-2	42-0217A
Assembled with motor		42-0204

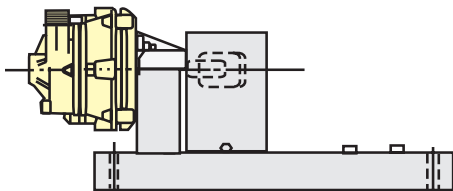

F.O. . I . S .

Registered trademarks:
 Viton -DuPont Dow Elastomers