

OPERATING-INSTRUCTION MANUAL

FOR

SERFILCO SERIES 2000

MULTIPLE INPUT AMPERE-HOUR/MINUTE TOTALIZER/PUMP CONTROLLER

SERIES 2000  
ELECTROPLATING BRIGHTENER CONTROLLER/TOTALIZER  
PRICE CODE NO. 56-0551

<u>INDEX</u>	<u>PAGE</u>
I DESCRIPTION	1 - 4
II INSTALLATION	5
III CHEMICAL ADDITION PUMPS	6
IV LOW CHEMICAL	6
V PRESET & RESET	7
VI TOTALIZER & RESET	7
VII DATA ENTRY & PROGRAMMING	7 - 9
VIII OPERATION	9
IX DATA TABLE	10
X ADVANCED FEATURES	11 - 12
XI CALIBRATION	13 - 14

## I DESCRIPTION

### Front Panel - Window View Diagram - Fig. 1

- A. Status Indicator Display: Six Lens LED
1. AMPERE HOURS - Red lens indicates unit has been programmed to totalize Ampere Hours. I.E: At the end of one hour the digital display will show 100 if 100 amperes passed through a 100 ampere shunt for one hour.
  2. AMPERE MINUTES - Red lens indicates unit has been programmed to totalize Ampere Minutes. I.E: At the end of one minute, the digital display will show 100 if 100 amperes passed through a 100 ampere shunt for one minute and will display 6000 at the end of one hour.
  3. PROGRAM MODE - Green lens indicates the unit is in the programming mode and will not totalize or control metering pumps, etc.
  4. PRESET REACHED - Red lens indicates the totalizer has reached the previously programmed preset amp-time value. The alarm relay will be activated and the pump output relays will be deactivated. The unit will no longer totalize when the preset is reached. To void preset feature calibrate preset to P99999999.
  5. LOW CHEMICAL - Red lens indicates the remote liquid sensor has activated the alarm relay due to low level of chemical additive. Totalizing will continue if shunt output voltage still exists.
  6. PUMP OUTPUT - Red lens indicates the pump signal operation. When programmed, the LED will blink 0 to 100 pulses per minute proportional to total shunt current for electronic chemical pumps. When used with ON-OFF manual pumps, the LED will stay on for a proportional time with a full one minute ON time at total shunt current. At minimum shunt current the LED will be ON for 10 percent (6 sec.) of each minute.

B. Digital Display: Eight Digit LED

1. When operating, the display shows totalized AMPERE HOURS or AMPERE MINUTES up to a total of 99999999 and then continues starting over from zero.
2. During 'Program Mode', the display shows the programmed rated shunt current for each of two shunt inputs and the preset amp-time value. The various ampere and preset amp-time values are viewed by scrolling with the arrow keys.

C. Programming Keypad

1. Data input for user programming:
  - . Shunt current rating.
  - . Ampere-hour or Ampere-minute totalizing.
  - . Preset value.
2. Numbers 0 through 9 used to enter the value shown on the key.
3. MODE - Used to enter the keypad data. Must be depressed when entering and exiting keypad operation. Depressing any other keypad during normal operation has no effect.
4. ARROWS (Up and Down) - To scroll through and review data entered for rated shunt currents and preset value.
5. ENTER - For entering or changing values for shunt and preset values.
6. CLEAR - For clearing new entries for shunt or preset values during data entry.
7. AH/AM - To select either Ampere-hour or Ampere-minute data entry.

### Underside of Enclosure

- A. Two 3-pin jacks for operating two electronic pulse pumps simultaneously.
- B. One 2-pin jack for level control sensor.
- C. Power supply. Prewired 120V/1/50-60, extension cord with plug, fused 5 amps. Cord and plug not included for 50 Hz.
- D. Nema 4X duplex 3-prong receptacle box, 120V/1/50-60, for operating two ON-OFF pumps simultaneously. Receptacle box is not included for 240V/1/50-60 service.

One 3/4" knockout plug for shunt lead wires and auxiliary alarm annunciators.

### Latchside of Enclosure

- A. RESET button for PRESET amp-time.
- B. RESET button for amp-time TOTALIZER.

### Rear Panel - Fig. 2

Loosen lock screw at latchside of front panel to access rear panel.

- A. Shunt Headers: No's. 1 through 2 and jumpers. The 50 mv, 100 mv and 200 mv positions are left, center and right. Refer to set-up instructions, Table 1 and Fig. 5.
- B. Span & Zero Adjustment Screws: These are not to be changed from factory set position. Consult with factory or qualified service technician.
- C. Power Supply Selector Switch: Switch reads 115V or 230V. The 115V position is for 115-120V/1/50-60 power supply. The 230V position is for 230-240V/1/50-60 power supply. Use small blade screwdriver to change switch position. To access switch depress spring hinge pin at top of front panel.
- D. Fuse & Holder: No. SLO-BLO 3AG fuse. To access fuse, depress spring hinge pin at top of front panel.

#### E. Horizontal Terminal Board:

- 1) Terminals 1,2,4. Power supply. Cord and plug prewired when 120V/1/50-60. If 240V/1/50-60, then cut plug from cord and replace with suitable plug.
- 2) Terminals 3,5,6. Power to one or two manual ON-OFF pump.
- 3) Terminals, 7,8,9. Lead wires to the 3-pin jacks at underside of enclosure for one or two electronic metering pumps.
- 4) Terminals 10,11. Alarm relay dry contacts for remote horn or light alarm. Max. 10 amps. Contacts are activated when PRESET is reached or at LOW CHEMICAL condition.

#### Vertical Terminal Board:

- 1) Terminals 1 to 4. Rectifier 1 through 2 shunt leads. Note polarity when making connections. Refer to Fig. 2. Terminals 5-16 are inactive.
- 2) Terminals 17, 18. Liquid level sensor.
- 3) Terminals 19, 21. Totalizer Reset.
- 4) Terminals 20, 21. Preset Reset.

#### G. Front Panel (Backside)

- 1) Span and zero adjustment screws for AMP-TIME are not to be repositioned by user. Contact factory or qualified service technician.
- 2) Master Reset: Do not depress. Master Reset is for factory service or qualified technician. If accidentally depressed, the controller will revert to programming mode.
- 3) Lithium ROM battery backup has 10 year life and maintains display and programmed data if power interruption. Battery size is approximately 1-1/2" x 11/16" (38mm x 17mm) and is identified by Dallas DS1225D-120).

## II INSTALLATION

- A. MOUNTING - Select a location for mounting the controller on a wall, panel or column having good visual and physical (hands-on) accessibility. Securely mount at eye level using the four holes in enclosure backside. Conduit or sealed cord strain relief connector must be used to maintain the controller enclosure integrity.
- B. POWER SUPPLY - A 5' extension cord, 120V/1/50-60 with three prong plug is pre-wired to the unit. Power supply selector switch is factory set at 120V position. Bring 120V power supply with female receptacle to within 5' of controller or remove extension cable and hard wire power supply to horizontal terminals No. 1, 2, 4.
- C. SHUNT LEADS FROM RECTIFIERS -
1. Record maximum rectifier amperage, rated shunt current, and shunt millivolt values for all rectifiers on data sheet provided.
  2. Shunt signal lines must be two conductor shielded cable and NOT run in conduit with power or other signal lines.
  3. Signal lines are required from each rectifier shunt.
  4. Make shunt No. 1 connections to terminals 1R, 2R, etc. until all shunt leads are connected. Note lead polarity on terminal strip vs. diagram Fig. 4. Shunt input polarity must be observed for proper operation.
  5. Rectifier No. 2 must correspond to terminals 3 and 4, etc.
- D. JUMPER PINS - Fig. 5 -
- Insert jumper to pin position corresponding to MV rating of shunt; 50, 100 or 200 MV.
- E. POWER SUPPLY
- For 240V/1/50-60 power supply it is necessary to hard wire to terminal strip. Be sure to position red Power Supply Selector Switch to 240V. Switch is mounted on rear panel, near lower left corner. Refer to Fig. 2.

### III CHEMICAL ADDITION PUMPS (Purchased Separately)

The Series 8000 can accommodate a maximum of four pumps; two of the electronic pulse type and two of the manual ON-OFF type. To simplify the instructions, it will be assumed that one or two of either type will be used. Maximum amperage for any combination of pumps is 10 amps.

- A. ELECTRONIC PULSE PUMPS - Controlled by 10 ft. cable equipped with a matching (3 pin) connector on underside of controller. Two connector terminals are provided for operating two pumps simultaneously. Bulletin P-607 Pumps require cable P.N. 56-0567 . The 60 Hz. pumps are to be connected to 120V/1/60 wall outlets. For 50 Hz. pump models the plug on end of pump power cord must be removed and replaced with appropriate style then plug into wall outlet. Attach 3-pin connector end of 10 ft. cable to controller underside and attach other end to pump. Do not plug into PVC duplex receptacle box furnished with controller. If you choose to use receptacle box for electronic pump then disconnect 10 ft. cable and set pump to internal pulse control.
- B. MANUAL ON-OFF PUMPS - Controlled by the PVC duplex receptacle box wired to controller horizontal terminal strip. Note, one or two pumps can be controlled simultaneously. For 50 Hz models the 115V plug on power cord must be removed and cord wired to horizontal terminals 3, 5, and 6. Two pumps may be wired to these terminals.
- C. PUMP OPERATION - Pumps furnished by Serfilco include operating instructions.

### IV LOW CHEMICAL

Install two-pin connector of optional liquid level sensor to underside of enclosure. When activated by low level in chemical reservoir, the LED indicator lamp will be energized and normally open (N.O.) alarm terminals 10 and 11 are energized closed.

An audible alarm can be wired to terminals 10 and 11. Maximum 10 amps.

## V PRESET & RESET

A preset value of ampere-time may be keypad programmed, 5,000 amps per hour for example. When PRESET value is reached, then the LED indicator lamp will be energized and N.O. alarm terminals 10 and 11 are energized. Depressing the PRESET RESET button deactivates the alarm and indicator lamp and establishes next PRESET value of 10,000 amp-hours (5000 + 5000).

## VI TOTALIZER & RESET

The eight digit readout is programmed to display ongoing totalized ampere-time. Depressing the TOTALIZER RESET button erases TOTALIZER amp-time display and reverts to new count from zero.

## VII DATA ENTRY & PROGRAMMING

Before programming the instrument it is necessary to record rectifier data. Refer to Data Table.

### A. Data Entry

The Series 2000 is factory calibrated to display zero (0) for rated shunt current and preset amp-time.

The shunt current parameters, ampere-minute or ampere-hour readout, and preset alarm settings are set by keypad entry as shown by flow chart Figure 6. The programming mode is enabled by depressing "MODE". Pressing the UP arrow allows scrolling through the shunt setting in order of L1 through L8 which represents rectifiers 1 through 8.

After shunt L2, the preset value P must be entered. If programmed P99999999, then the preset and alarm features are deleted from the control program.

The direction of scrolling can be controlled by using the UP or DOWN arrow key. To change an entry value shown on the display, depress the ENTER key, enter the desired value, then depress the ENTER key again. The programming mode LED will flash once to show data was entered. If an entry error must be corrected when entering a new value, depress the CLEAR key and re-enter the new value. Depress the MODE key to place the system in operation as indicated by the green LED program mode indicator going off.

## B. PROGRAMMING

1. AMP-HOURS OR AMP-MINUTES - While in the MODE setting, as indicated by the green LED, the AH/AM keypad can be operated to toggle between the choices of Ampere-Hour or Ampere-Minute totalizing readout.
2. RATED SHUNT CURRENT - While in the MODE setting as indicated by the green LED, the rated shunt current for rectifier LI through L2 should be entered.

Example: Rated shunt current 1000 amps. Depress MODE and LI will appear with a zero (0) value. Depress ENTER and the zero will disappear. Depress numbered keypad for rated shunt current 1000. Depress ENTER and the 1000 is programmed. Depress UP arrow to L2 and repeat procedure.

3. PRESET - While in the MODE setting, as indicated by the green LED, the PRESET P prefix will appear after L2.

Example: Preset to be 10,000 amp-hours, depress up or down arrow until prefix P appears. Depress ENTER and the zero will disappear. Depress numbered keypads 10000. Depress ENTER and the preset 10000 amp-hours is programmed.

To exit the programming mode, depress MODE and the green LED is extinguished.

When PRESET amp-time value is programmed 9999, then PRESET and alarm features are deleted from the control program.

4. MILLIVOLT SHUNT OUTPUT - Each shunt output must be selected on the power supply printed circuit board via jumpers as shown on illustration Fig. 5. Three selections are possible; 50 millivolt, 100 millivolt and 200 millivolt, covering the majority of known shunt outputs. The correct jumper location for each shunt input is as follows.

Note, pin positions left center and right.

SHUNT NUMBER	LEFT 50 MV	CENTER 100 MV	RIGHT 200 MV
1	J202	J203	J204
2	J205	J206	J207

Only one jumper must be installed on any one shunt at once. If a shunt input is not used, there still must be an installed jumper. Note Fig. 5 showing proper jumper installation.

1. Jumpers are factory installed at 50 MV position.
2. Correct position of jumper is with '3M' at top.
3. Spare jumpers included with instruction packet.
4. Each jumper must be installed on pin position that corresponds to the 50, 100 or 200 MV output recorded on Data Table for each rectifier.. All pin headers without a dedicated rectifier must have a jumper in any one of the three pin positions.
5. If millivolt output is other than 50, 100 or 200 MV, then refer to Advanced Features I to determine compensated rated shunt value for data entry.

### VIII OPERATION

Once the controller is installed, wired with power, programmed via the keypad and the shunt jumpers properly configured, the unit is ready to operate. The MODE Keypad must be operated to remove the unit from the programming mode as shown by the green LED extinguished. The totalizer will increment when the rectifiers are turned on and display total energy as either ampere-hours or ampere-minutes.

When the totalizer equals the PRESET value, the alarm relay will operate and the chemical pumps will turn OFF. Depressing the PRESET RESET button will place the unit back into operation and will shut off again when the PRESET amount is again reached.

Depressing the TOTALIZER RESET button will reset the digital totalizer reading to zero.

IX DATA TABLE

Record rectifier data before calibrating instrument.  
 IMPORTANT: Rectifier No. 1 must be wired to vertical terminal strip connections 1R, with attention to + and - polarity. Same procedure for all rectifiers.

RECTIFIER NO.	I RECTIFIER MAXIMUM AMPERAGE	II SHUNT RATED AMPERAGE	III SHUNT MILLIVOLT OUTPUT
1	_____	_____	_____
2	_____	_____	_____

COLUMN I Maximum amperage of rectifier.

COLUMN II Rated current of shunt. This data will be entered in controller via keypad.

COLUMN III Millivolt output at rated current. These values will be 50 MV, 100 MV or 200 MV and jumper must be placed in corresponding position and on rear panel pin header for each rectifier. All headers without dedicated rectifier must have a jumper in any one of the three pin positions. Refer to Fig. 5.

X ADVANCED FEATURES

1. When shunt voltage drop is other than 50, 100 or 200 MV, then the instrument entry value for maximum rectifier amperage is compensated per the following.

A. Place jumper in pin position which is closest to shunt MV value. Example; for shunt value of 125 MV place jumper at 100 MV position.

B. Use the formula below to arrive at the 'compensated' rated shunt current. (RSC).

$$\text{Compensated RSC} = \frac{\text{jumper position MV}}{\text{shunt MV}} \times \text{Rated shunt current}$$

No. 1 Example:

125 MV shunt, 100 MV jumper position, 1500 Amp rated shunt current.

$$\text{Compensated RSC} = \frac{100}{125} \times 1500 = 1200 \text{ Amps}$$

Programmed data entry for this shunt should be 1200 Amps.

No. 2 Example:

175 MV shunt, 200 MV jumper position, 2000 Amp rated shunt current.

$$\text{Compensated RSC} = \frac{200}{175} \times 2000 = 2285 \text{ Amps}$$

Programmed data entry for this shunt should be 2285 Amps.

2. Preset alarm relay may be connected, via control relay, to rectifier power supply to shut-down main rectifier power supply when 'Low Chemical' or 'Preset' condition occurs.

### 3. Additional Chemical Pumps

- A. Four chemical metering pumps can be operated simultaneously. Two of the electronic type and two of the manual on-off type. Use pin jacks at underside of case and duplex receptacle.
- B. Three or more of the manual ON-OFF pumps can be activated by the same control circuit terminal numbers if total pump current does not exceed 10 amps.
- C. A third or fourth electronic pump Bulletin P-607 can be activated from the lead pump by use of a Pulse Transmitter - Price Code No. 26-0006.

## XI CALIBRATION

Only factory authorized service technician is to perform field service and calibrations.

1. Equipment Required for Field Servicing/Calibration
  - a. Precision 0 - 999.0 millivolt direct current (DC) source
  - b. Frequency meter, 0 to 100 KHZ
  - c. Multimeter, digital, DC
  - d. Oscilloscope
2. Input Shunt Amplifier
  - a. For each shunt input, connect voltmeter between the respective operational amplifier, pin 7 and common DC, TB203-11. Adjust the zero trimmers for 0.00 volts DC with shunt input voltage at 0.00 volts (shunted input).
  - b. For each shunt input with the shunt jumper at the 50 millivolt location, adjust the respective span trimmers for 1.00 volts DC.
  - c. Note the measured voltages will take several seconds to stabilize when making big step changes.
3. Pump control Oscillator
  - a. Connect oscilloscope to view pulses at 1C215 pin 1.
  - b. With zero input signal, adjust trimmer R325 for no pulse output.
  - c. Connect frequency meter to 1C215 pin 1. With full scale shunt input of 50 millivolt, adjust R210 for an indicated frequency of 13,647.87 hertz.
4. Processor Input Signal
  - a. Connect oscilloscope to view pulses at test point TP-101.
  - b. With keypad, place unit in programming mode.
  - c. With zero shunt input signal, adjust trimmer R112 (zero) for no pulse output.
  - d. With full scale input at shunt #1, adjust trimmer R117 (span) for 10,000.00 hertz.

After making calibration adjustments, return the keypad mode to the proper display before carefully closing the unit cover.

The Pump Controller incorporates sensitive CMOS type integrated circuit devices and normal techniques and care must be exercised when working on the printed circuit boards.

If calibration difficulties or equipment operation problems occur, it is suggested the unit be returned to the factory for expert and qualified service.

# SERIES 2000

AMPERE  
HOURS



AMPERE  
MINUTES



PROGRAM  
MODE



PRESET  
REACHED



LOW  
CHEMICAL



PUMP  
OUTPUT

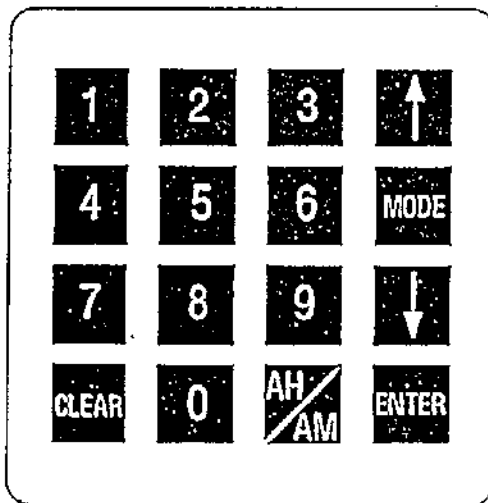
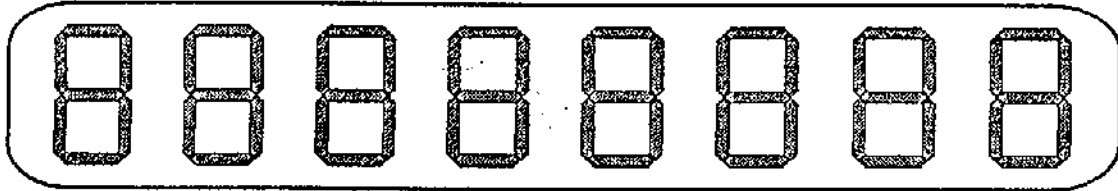

**SERFILCO**®

Northbrook, IL

**AMPERE-TIME BRIGHTENER/CHEMICAL  
PUMP CONTROLLER**

FIG. 1

RECTIFIER No.

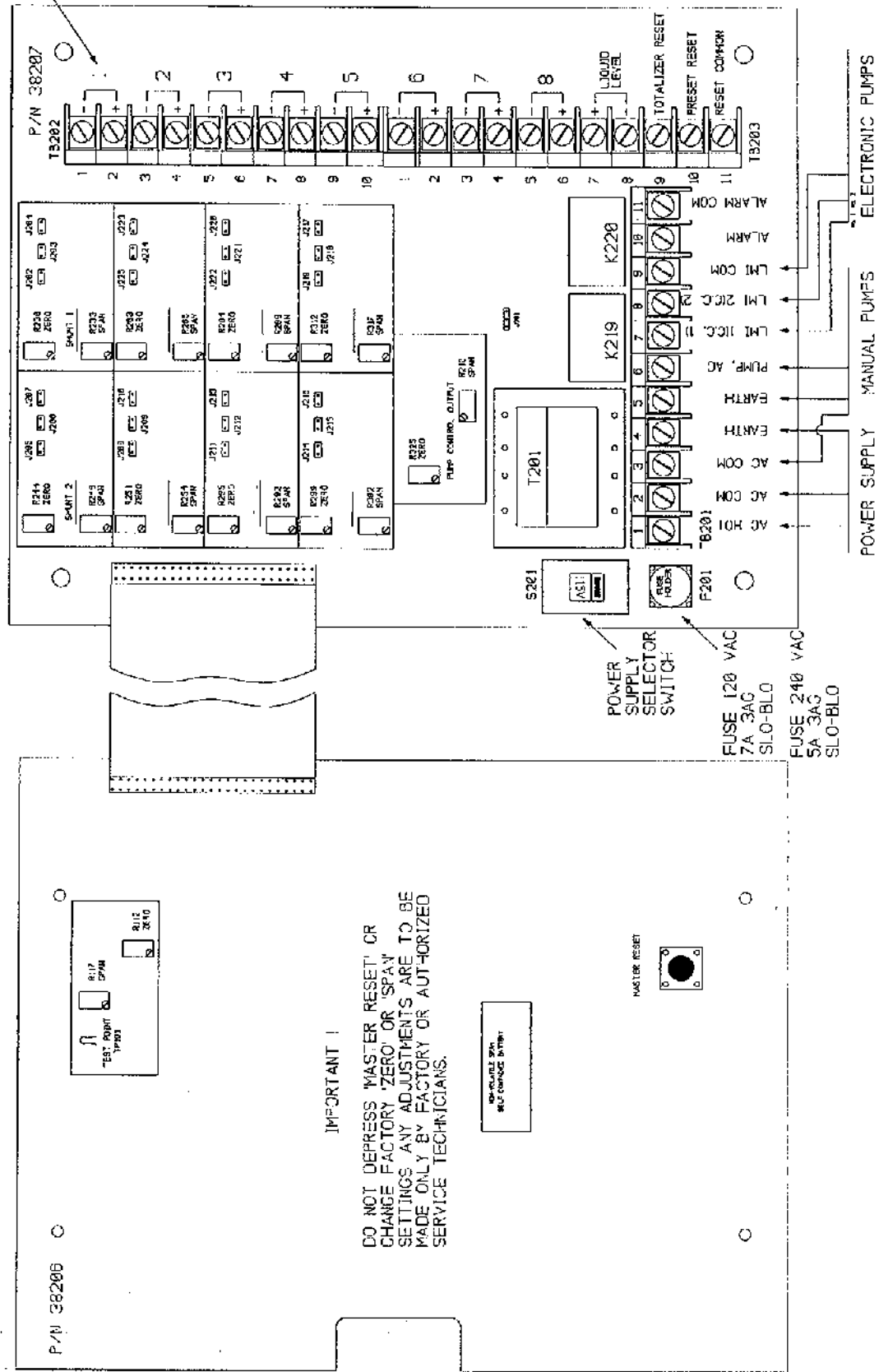

FRONT PANEL (BACK SIDE)

Fig. 2

Fig. 3

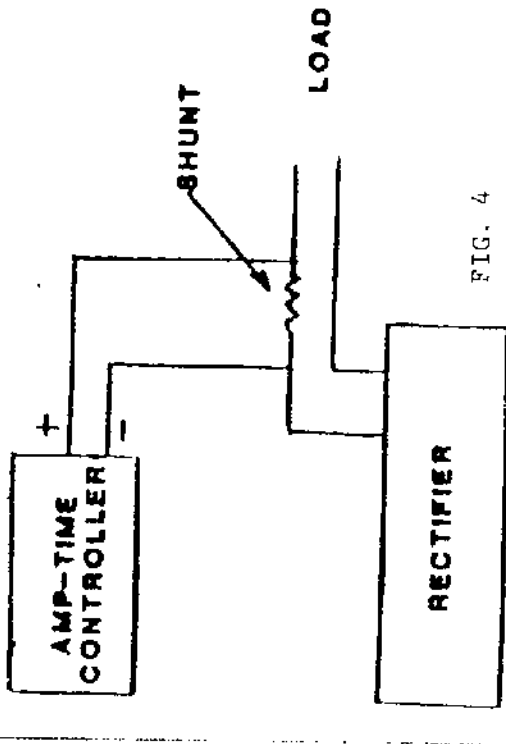
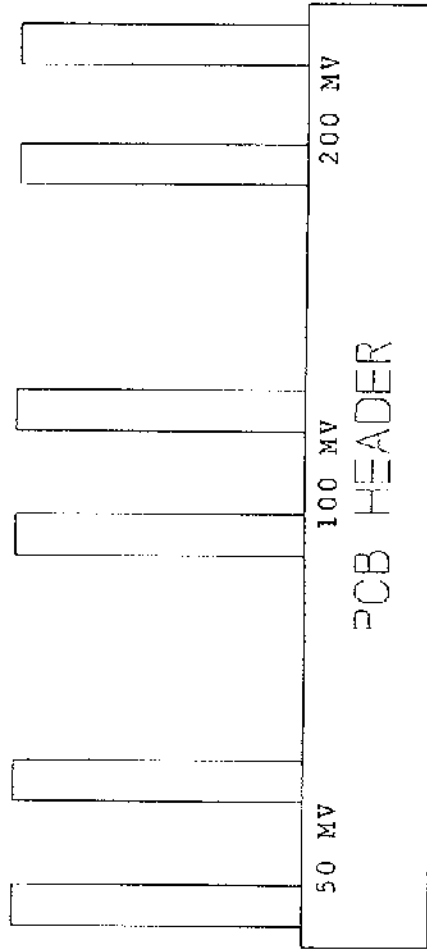
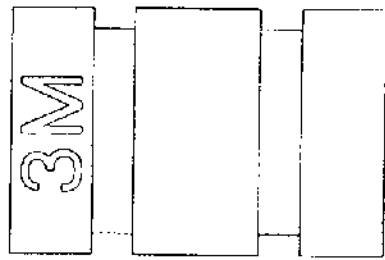

FIG. 4

INSTALL JUMPERS IN THE ORIENTATION SHOWN ( WITH THE 3M LETTERS AT THE TOP.)  
 INSTALLING JUMPER INCORRECTLY WILL DAMAGE JUMPER.

FIG. 5

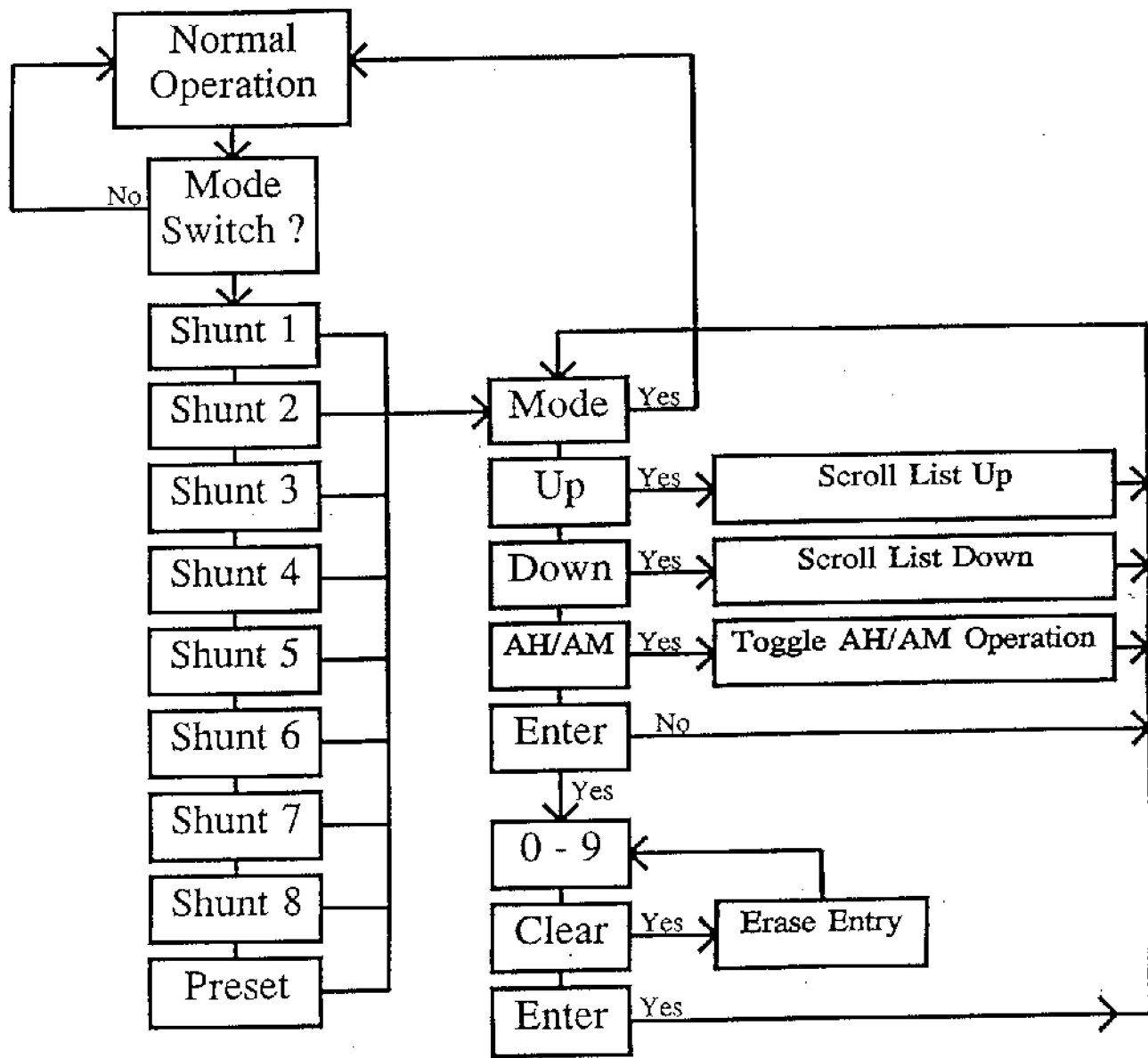

FIG. 6